



VIRTUE OF HEIGHT



Metal Ceiling | Exterior Elevation



What makes you see as a defined path? The clear and visible path seen is always in form of a line. Line as a form and the path of linear movement creates a beautiful harmony of achieving height.

What can make us feel complete? All four corners covered through a path drawn using lines. Lines of your journey could it be professional or personal. The Squaring up most important things in life is what gives a feeling of abundance. So is the form Square, we call it as a complete square. Different situations, different fronts, but the final outcome has to be a successfully completed task. Task that Squares up your success stories.

The series of lines creates a base and those lines in planned harmony creates a complete square.

Schepper® intends to install the best of possible lines and squares in your surroundings that defines your work atmosphere or home environment. The virtue of height where your guests are overwhelmed seeing your success on heights.

Team at Schepper®, delivers multiple applications, multiple variants and colours for your walls and ceilings.

The wall of your building that gives the attractive look for passersby, can be well done by Schepper® products.

Those ceilings that defines the height of your journey can be designed well with Schepper® products and its all available variants.

About us

Schepper was founded in Ahmedabad in 2020. Schepper is dedicated to the users with sense of design and Innovative style of modern architecture. Schepper brings you a diversity in molded metal products such as metal false ceilings, exterior elevations and facade.

We provide our products and execute our services across India. Our primary offices are in Ahmedabad (Gujarat) and Hyderabad (Telangana), and our supply chain actively brings forth orders from all preferred regions of India.

We have completed **300+** projects over the course of two years, and have also come up with **3+** million square feet of supply and installation.

Schepper puts a strong emphasis on total client satisfaction. Our modern and technologically sound workforce, which includes skilled and experienced labour ensures that projects are finished on schedule. To assure that our products last for a long time, we also take location and weather into account.

Our Presence in India...

Bangalore, Bhubaneshwar, Chennai, Hyderabad, Kolkata, Kochi, Pune.

Mission

To propose a wide range of innovations in architectural products and to improve our skills with time. We thrive to diversify ourselves and procure more employment for the economy.

Vision

Our Vision is to expand our horizon by innovating in architectural products. We are in constant process of up-scaling our standards and serve our customers across the globe. Our growth will be extended in contributing for raise in employment and economical growth.

We use the following metal standards for our finished products

Aluminium Alloy:

AA1100 / AA8011 / AA3003 / AA3105

Galvalume Plain Steel Coil:

Alloy-coated product contains 55% aluminium, 43.5% zinc and 1.5% silicon by weight.



CONTENTS

LINEAR CEILINGS

LINEAR CEILING - 84C / 184C	10
LINEAR CEILING - 84R / 184R 84RF / 184RF	12
LINEAR CEILING 150F	14

BAFFLE CEILINGS

U SHAPE BAFFLE - FL	18
U SHAPE BAFFLE - MULTI HEIGHT	20
U SHAPE BAFFLE - MULTI WIDTH	22

GRID CEILING / TILE

LAY - IN TILE	26
LAY - IN TEGULAR	28
CLIP IN TILE	30
HOOK ON TILE	32

SPECIAL CEILINGS

OPEN CELL CEILING	36
CLOUD CEILING	38
BEZEL CEILING	40
TUBE BAFFLE	42

EXTERIOR CLADDING / ELEVATION

WALL CLADDING 84C	46
U SHAPE CLADDING	48
U SHAPE CLADDING MULTI WIDTH	50
CLADDING 84R	52
LOUVERS SL4	54
LOUVERS H3	56

GRID / ACCESSORIES / FINISH PROFILES	58
--------------------------------------	----

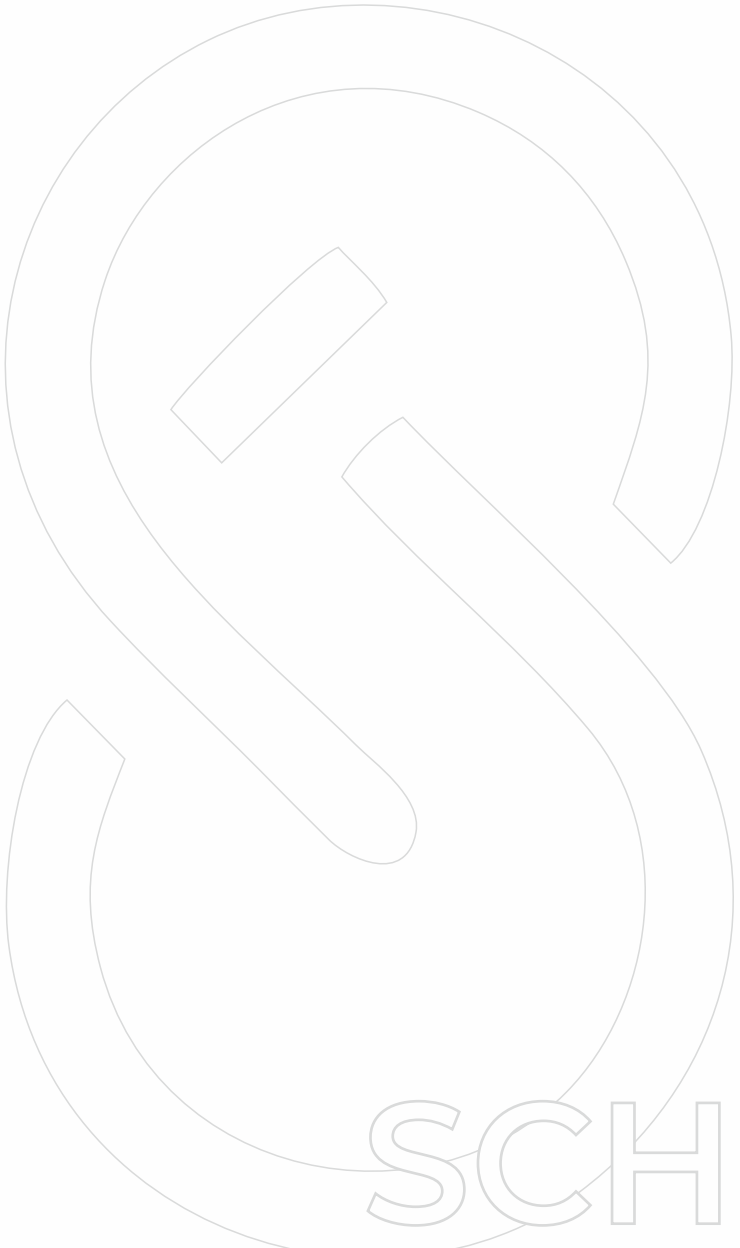

SCHEPPER

LINEAR CEILINGS



Linear 84C / 184C

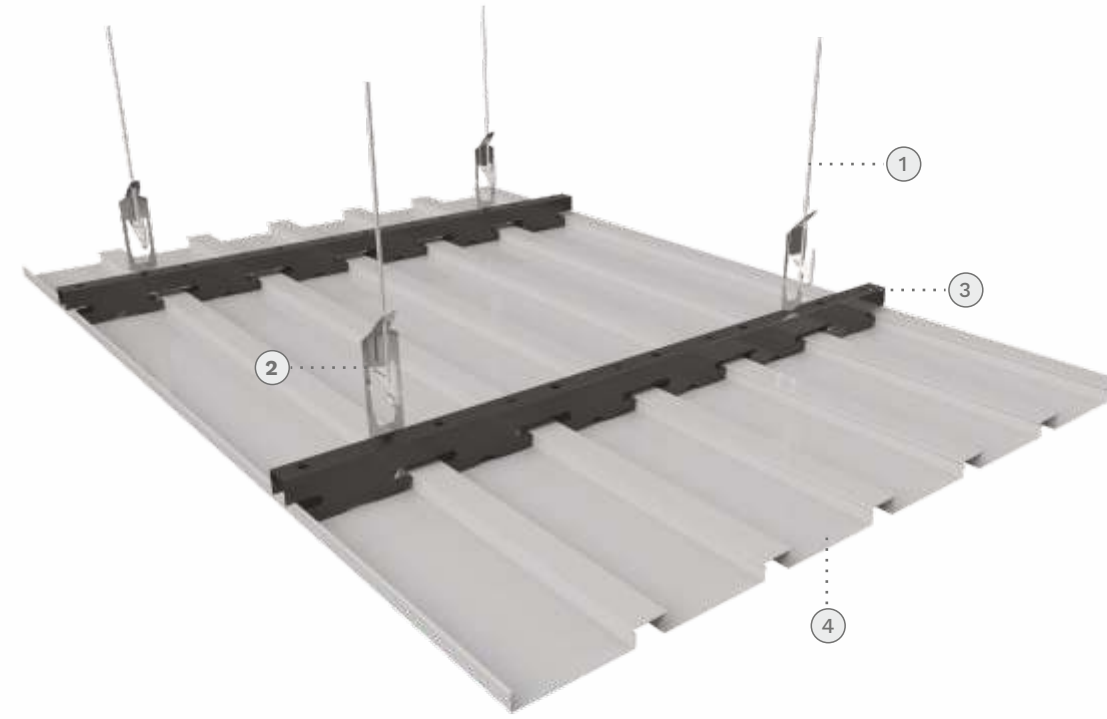

No.	Description
1	GI Rod
2	Height Adjustable Clip
3	Carrier
4	84C Panel



LINEAR CEILING - 84C / 184C

LINEAR 84C / 184C Metal False Ceiling is an arrangement of multiple panels stacked adjacent to each other with grooves in each member. It offers more durability with less maintenance as compared to wooden false ceilings. These panels can be customized according to the aesthetic requirements and fulfill the acoustical needs of the project.

PANEL SPECIFICATION

Available Sizes	Width(mm)	Length (mm)	Depth (mm)	Thickness (mm)
60C	60	Upto 5000	15	0.50 - 0.71
84C	84	Upto 5000	15	0.50 - 0.71
136C	136	Upto 5000	15	0.50 - 0.71
184C	184	Upto 5000	15	0.50 - 0.71
212C	212	Upto 5000	15	0.50 - 0.71
284C	284	Upto 5000	15	0.50 - 0.71

Profile and Accessories

Panel Coupler	-	-	-	0.50 - 0.70
Carrier 16mm Groove	20	Upto 4000	-	0.60
Carrier 8mm Groove	-	Upto 4000	-	0.60
Carrier Coupler	-	150	-	0.60
Customized Profiles (For Border Finish)	-	Upto 2440	-	0.50 - 0.70



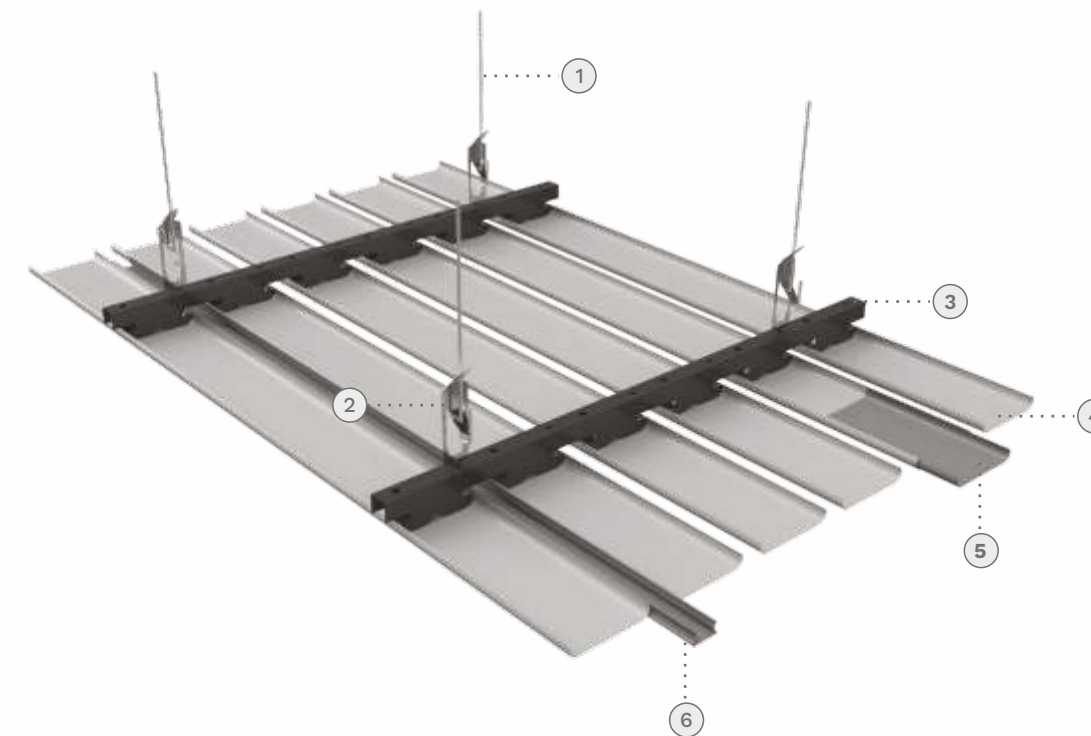



No.	Description
1	GI Rod
2	Height Adjustable Clip
3	Carrier
4	84R Panel
5	Panel Coupler
6	Flush Cap



Corrosion Resistance



Fire Classification



Easy Wash/Clean



Light Reflectance



Acoustic Property



Humidity Resistance



Anti Microbial



Green Building Material

LINEAR CEILING - 84R / 184R 84RF / 184RF

LINEAR CEILING 84R/184R 84RF/184RF consists of a continuous set of panels and gives a sort of larger visualization of the structure. It can be used both in the interior as well as the exterior of the structure. Panels with high mirror finish can be used for luxurious projects.

PANEL SPECIFICATION

Available Sizes	Width(mm)	Length (mm)	Depth (mm)	Thickness (mm)
38R	38	Upto 5000	15	0.50 - 0.71
60R	60	Upto 5000	15	0.50 - 0.71
84R	84	Upto 5000	15	0.50 - 0.71
136R	136	Upto 5000	15	0.50 - 0.71
212R	212	Upto 5000	15	0.50 - 0.71
284R	284	Upto 5000	15	0.50 - 0.71
184R	184	Upto 5000	15	0.50 - 0.71

Profile and Accessories

Panel Coupler	-	-	-	0.50 - 0.70
Carrier	20	Upto 4000	40	0.60
Carrier Coupler	20	-	40	0.60
Customized Profiles (For Border Finish)	-	Upto 2440	-	0.50 - 0.70
Flush Cap	16	Upto 3000	15	0.40 - 0.50

Linear Ceiling 84R / 184R 84RF / 184RF





Linear Ceiling 150F

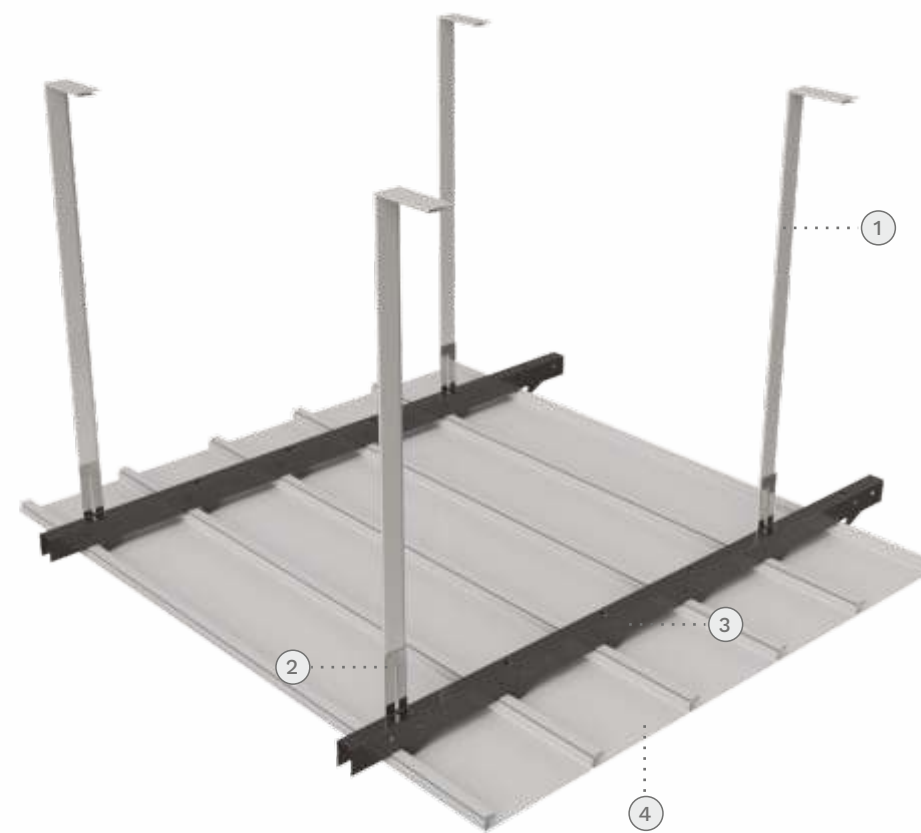

No.	Description
1	Suspension Angle
2	T Leveler
3	Carrier
4	150F Panel

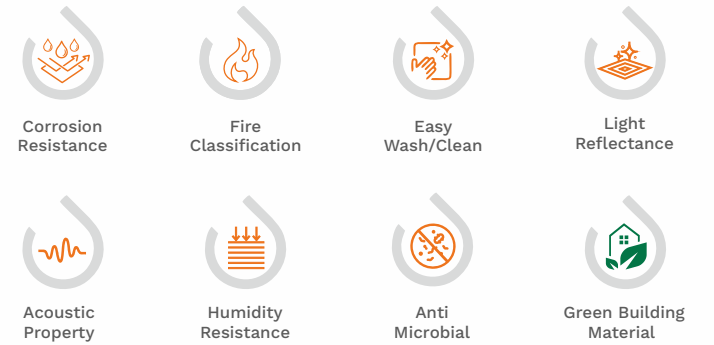

LINEAR CEILING 150F

LINEAR 150F can be designed as a closed ceiling/cladding with the capability to resist corrosion and all types of weather effects. As it is less prone to cracking or losing finish, it is most widely used in petrol pumps, toll plazas, wall cladding of industries, etc.

PANEL SPECIFICATION

Available Sizes	Width(mm)	Length (mm)	Depth (mm)	Thickness (mm)
150F	150	Upto 6000	16	0.50 - 0.71

Profile and Accessories

Panel Coupler	-	150	-	0.50 - 0.70
Carrier	20	Upto 4000	40	0.60
Carrier Coupler	20	-	40	0.60
T-Leveler	-	-	-	1.20
Suspension Angle	-	-	-	0.50
Customized Profiles (For Border Finish)	-	Upto 2440	-	0.50 - 0.70





SCHEPPER

BAFFLE CEILLINGS



U Shape Baffle - FL

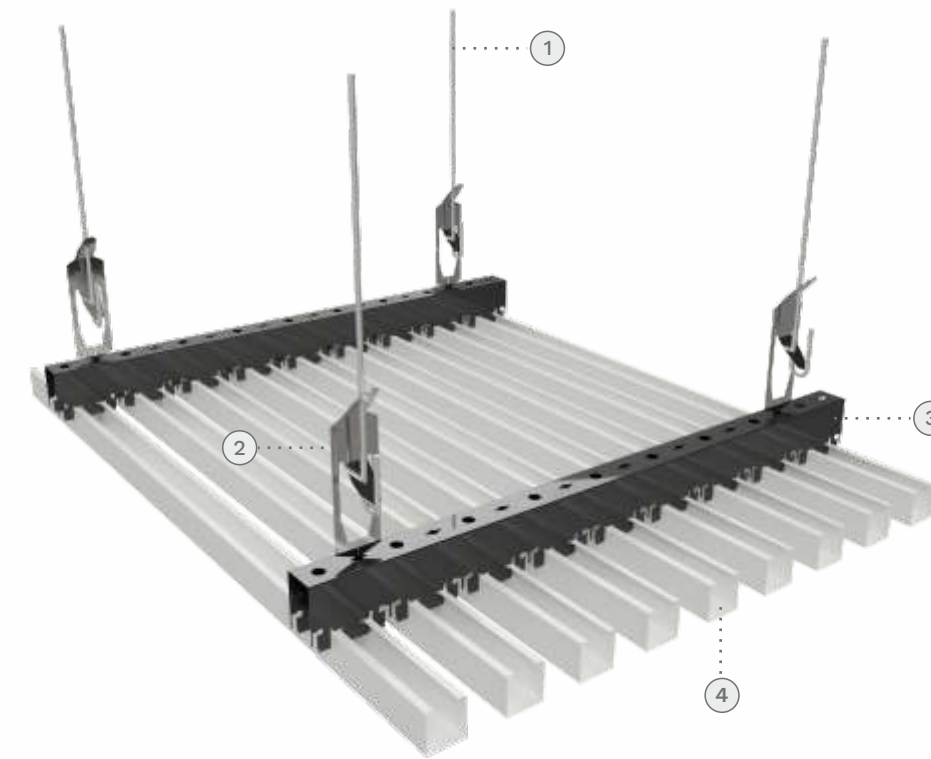

No.	Description
1	GI Rod
2	Height Adjustable Clip
3	Carrier
4	U Shape Panel

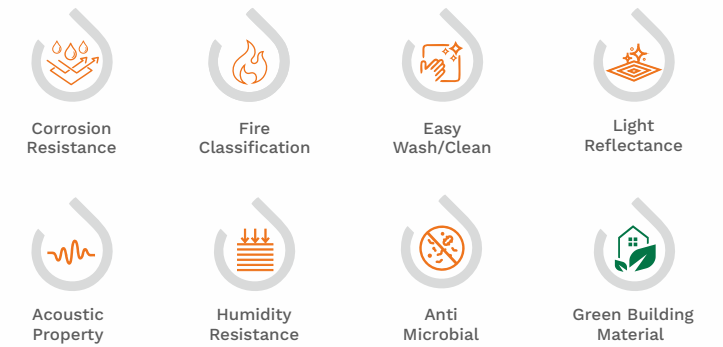

U SHAPE BAFFLE - FL

U SHAPE BAFFLE CEILING is made in GS or Aluminium with a powder coating finish offering good resistance and great durability. These are easy to install either horizontally or vertically with a variety of shapes, colors, materials, and finishes. Most widely used in cladding, these panels are cost-effective with endless designs and other utility choices.

PANEL SPECIFICATION

Available Sizes	Width(mm)	Length (mm)	Depth (mm)	Thickness (mm)
U Shape 13*50*13 13*75*13	50 - 75	Upto 5000	13	0.50 - 0.71
U Shape 25*25*25 25*50*25 25*75*25	25 - 50- 75	Upto 5000	25	0.50 - 0.71
U Shape 50*25*50 50*50*50 50*75*50	25 - 50- 75	Upto 5000	50	0.50 - 0.71
U Shape 75*25*75	25	Upto 5000	75	0.50 - 0.71
U Shape 100*25*100 100*50*100	25-50	Upto 5000	100	0.50 - 0.71
U Shape 125*25*125 125*50*125	25-50	Upto 4000	125	0.50 - 0.71
U Shape 150*25*150 150*50*150	25-50	Upto 4000	150	0.50 - 0.71

Profile and Accessories

Profile/Accessory	As Per Panel Size			
End Cap	-	-	-	-
Panel Coupler	-	150	-	0.50
Carrier	20	Upto 4000	40	0.60
Carrier Coupler	20	-	40	0.60
Customized Profiles (For Border Finish)	-	Upto 2440	-	0.50 - 0.70







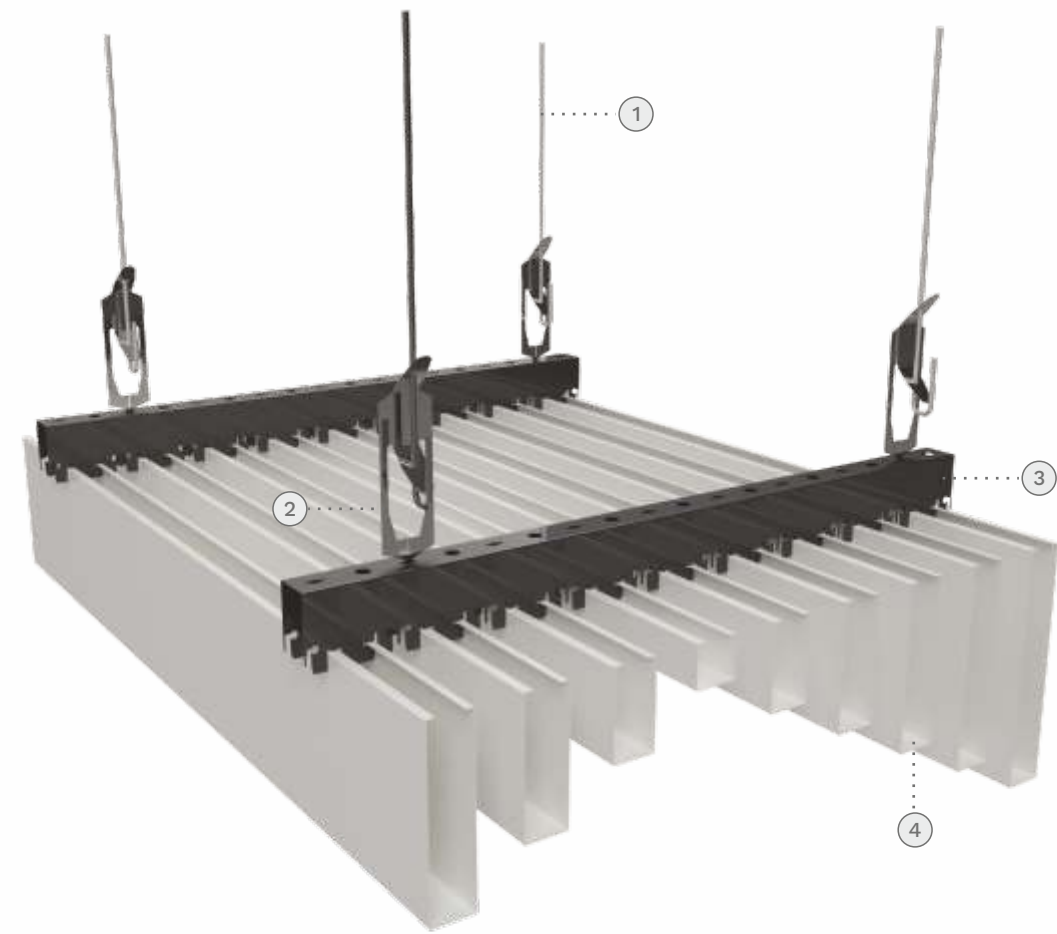
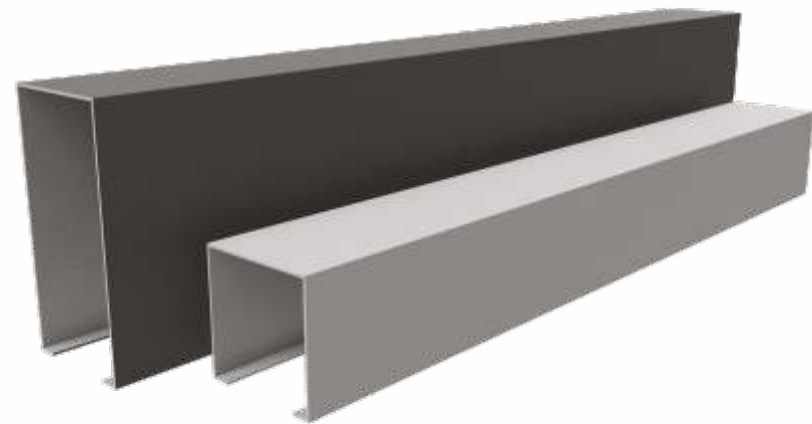

U Shape Baffle - Multi Height



No.	Description
1	GI Rod
2	Height Adjustable Clip
3	Carrier
4	Multi Height U Shape Panel

-  Corrosion Resistance
-  Fire Classification
-  Easy Wash/Clean
-  Light Reflectance
-  Acoustic Property
-  Humidity Resistance
-  Anti Microbial
-  Green Building Material

U SHAPE BAFFLE - MULTI HEIGHT

U SHAPE BAFFLE CEILING - MULTIPLE HEIGHT is like U Shape baffle ceilings but with different heights as customized. An arrangement of similar width but with a varying height of each panel gives a wavy look to the ceiling.

PANEL SPECIFICATION

Available Sizes	Width(mm)	Length (mm)	Depth (mm)	Thickness (mm)
U Shape 13*50*13 13*75*13	50 - 75	Upto 5000	13	0.50 - 0.71
U Shape 25*25*25 25*50*25 25*75*25	25 - 50 - 75	Upto 5000	25	0.50 - 0.71
U Shape 50*25*50 50*50*50 50*75*50	25 - 50 - 75	Upto 5000	50	0.50 - 0.71
U Shape 75*25*75	25	Upto 5000	75	0.50 - 0.71
U Shape 100*25*100	25	Upto 5000	100	0.50 - 0.71

Profile and Accessories

Panel Coupler	-	150	-	0.50 - 0.70
Carrier	20	Upto 4000	40	0.60
Carrier Coupler	20	-	40	0.60





U Shape Baffle - Multi Width

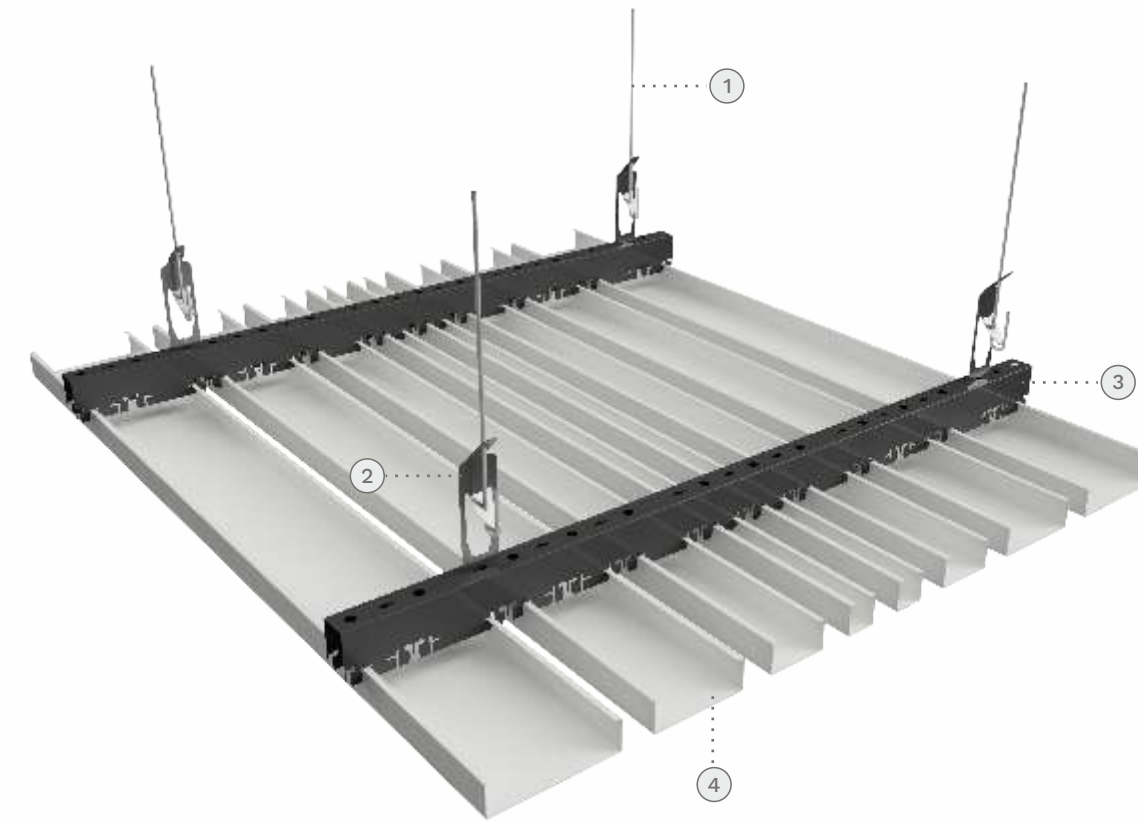

No.	Description
1	GI Rod
2	Height Adjustable Clip
3	Carrier
4	Multi Width U Shape Panel

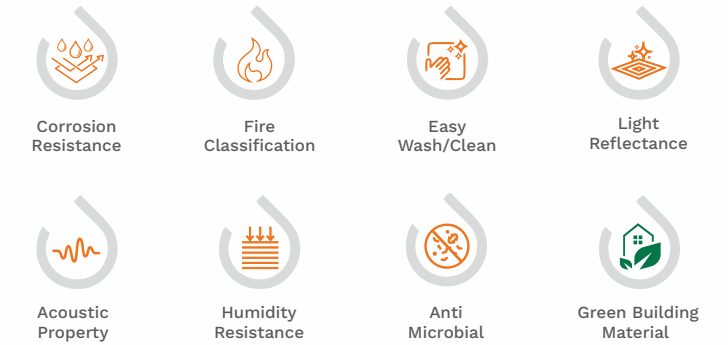

U SHAPE BAFFLE - MULTI WIDTH

U SHAPE BAFFLE CEILING - MULTIPLE WIDTH like U Shape baffle ceiling but with different widths as customized. An arrangement of similar height but with a varying width of each panel gives a wavy look to the ceiling.

PANEL SPECIFICATION

Available Sizes	Width(mm)	Length (mm)	Depth (mm)	Thickness (mm)
U Shape 13*50*13 13*75*13	50 - 75	Upto 5000	13	0.50 - 0.71
U Shape 25*25*25 25*50*25 25*75*25	25 - 50- 75	Upto 5000	25	0.50 - 0.71
U Shape 50*25*50 50*50*50 50*75*50	25 - 50- 75	Upto 5000	50	0.50 - 0.71
U Shape 75*25*75	25	Upto 5000	75	0.50 - 0.71
U Shape 100*25*100	25	Upto 5000	100	0.50 - 0.71

Profile and Accessories

Panel Coupler	-	150	-	0.50 - 0.70
Carrier	20	Upto 4000	40	0.60
Carrier Coupler	20	-	40	0.50
Customized Profiles (For Border Finish)	-	Upto 2440	-	0.50 - 0.70





SCHEPPER

GRID CEILING/TILE



No.	Description
1	GI Rod
2	Butterfly Clip
3	Main 'TEE'
4	Cross 'TEE'
5	Lay In Tile

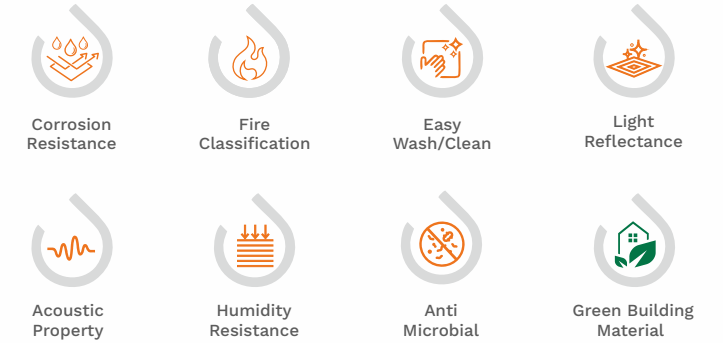

LAY - IN TILE

LAY IN TILE creates a modular arrangement on the selected grid with a variety of sizes, offering fire resistance, corrosion resistance, thermal stability, weather resistance, etc. It is an optimal option with acoustic control using perforated panels. These tiles can be used for various building sectors according to the demands.

PANEL SPECIFICATION

Available Sizes	Square Tile	Tegular	Thickness (mm)
Lay In Tile	575*575 585*585 595*595	8	0.50 - 0.71
Lay In Tile	575*1175 585*1185 595*1195	8	0.50 - 0.71
Lay In Tile	275*1175 285*1185 295*1195	8	0.50 - 0.71

Profile and Accessories

	Width (mm)	Length (mm)	Height (mm)	Thickness (mm)
Cross 'TEE'	15 24	600 1200	32 / 38	0.30
Main 'TEE'	15 24	3000	32 / 38	0.30
Butterfly Clip	-	-	-	0.50
Customized Profiles (For Border Finish)	18	Upto 2440	20	0.50 - 0.70

Lay - In Tile



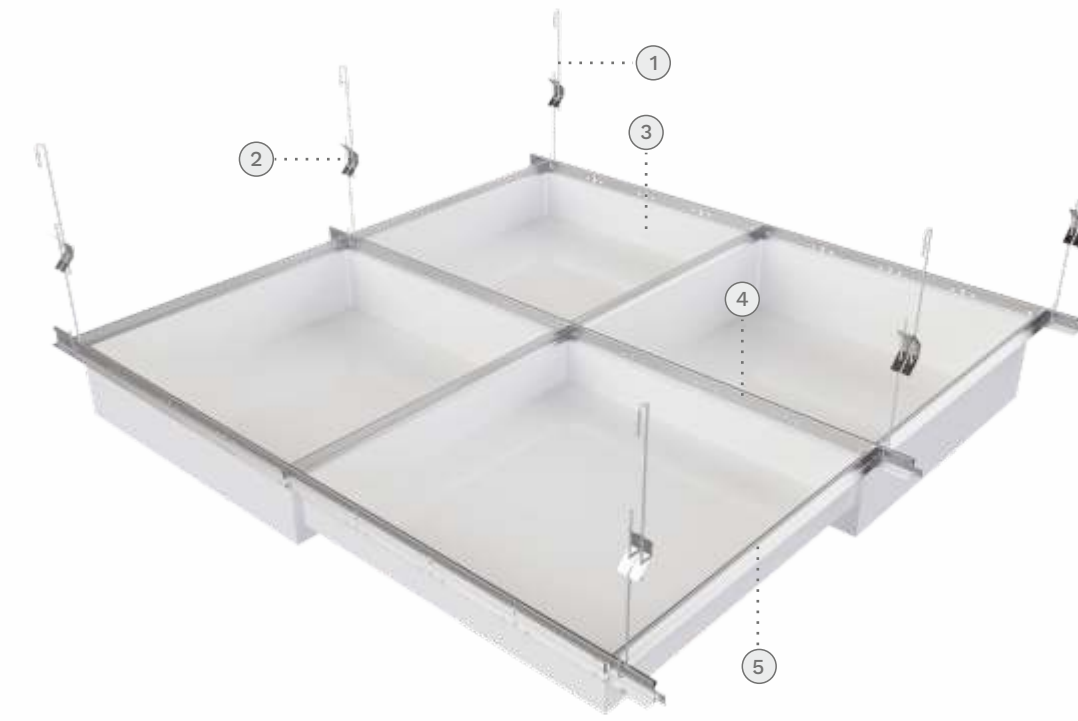

No.	Description
1	GI Rod
2	Butterfly Clip
3	Main 'TEE'
4	Cross 'TEE'
5	Multi Tegular Tile

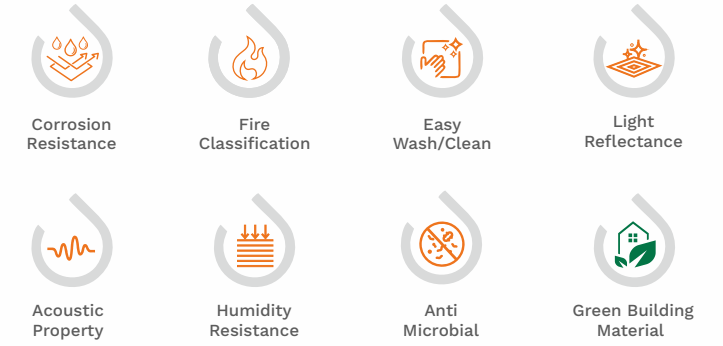

LAY - IN TEGULAR

LAY - IN MULTIPLE TEGULAR ceilings are easy to install and remove when needed. It is a system of box-like members attached to the main ceiling with suspension rods. The height of the rod can be adjusted according to the design criteria. This type of ceiling is a staple in the design and architecture section with easy installation.

PANEL SPECIFICATION

Available Sizes	Width (mm)	Length (mm)	Tegular (mm)	Thickness (mm)
Lay In Tile	575*575	575*575	8 25 50	0.50 - 0.71
Lay In Tile	575*1175	575*1175	8 25 50	0.50 - 0.71
Lay In Tile	275*1175	275*1175	8 25 50	0.50 - 0.71

Profile and Accessories

Cross 'TEE'	15 24	600 1200	32 / 38	0.30
Main 'TEE'	15 24	3600	32 / 38	0.30
Big Clip	-	-	-	0.50
GI Rod	-	-	-	4
Customized Profiles (For Border Finish)	-	Upto 2440	-	0.50 - 0.70

Lay - In Tegular

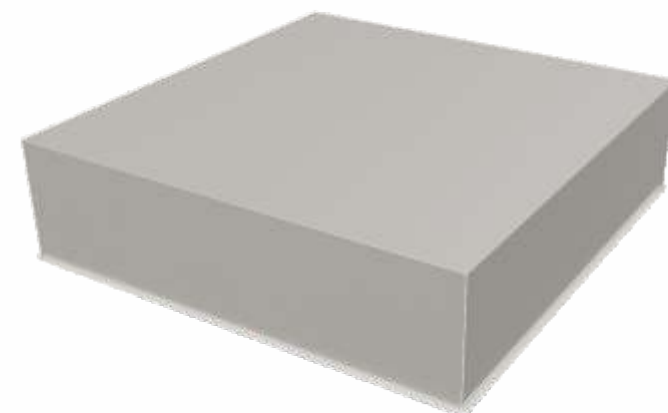



Clip In Tile

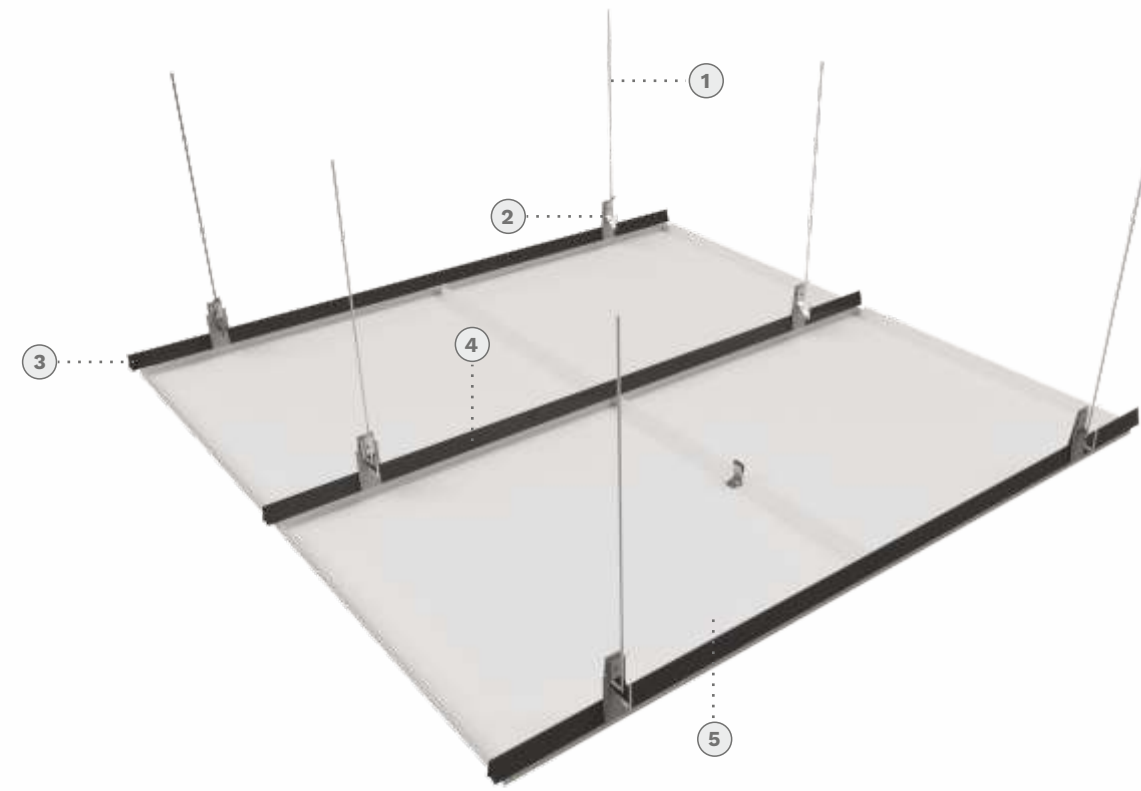

No.	Description
1	GI Rod
2	Small Clip
3	Hold On Hanger
4	Clip In Carrier
5	Clip In Tile



Corrosion Resistance



Fire Classification



Easy Wash/Clean



Light Reflectance



Acoustic Property



Humidity Resistance



Anti Microbial



Green Building Material

CLIP IN TILE

CLIP IN TILE is a square aluminum ceiling that comes in a wide range of sizes. Clip In Ceiling has perfect fire prevention, heat protection, good sound absorption, performance, and moisture-proof functionality. These ceilings help in taking design ideas into reality and are mainly used in office buildings, hotels, etc.

PANEL SPECIFICATION

Available Sizes	Width (mm)	Length (mm)	Tegular (mm)	Thickness (mm)
Clip In Tile	600*600	600*600	35 & 25	0.50 - 0.71
Clip In Tile	600*1200	600*1200	35 & 25	0.50 - 0.71
Clip In Tile	1256*264	1256*264	35 & 25	0.50 - 0.71

Profile and Accessories

Carrier	-	-	30	0.60
Carrier Coupler	-	-	30	0.50
Hold On Angle	-	-	30	0.50
Small Clip	-	-	-	0.50
GI Rod	-	-	-	4
Customized Profiles (For Border Finish)	-	Upto 2440	-	0.50-0.70





Hook On Tile

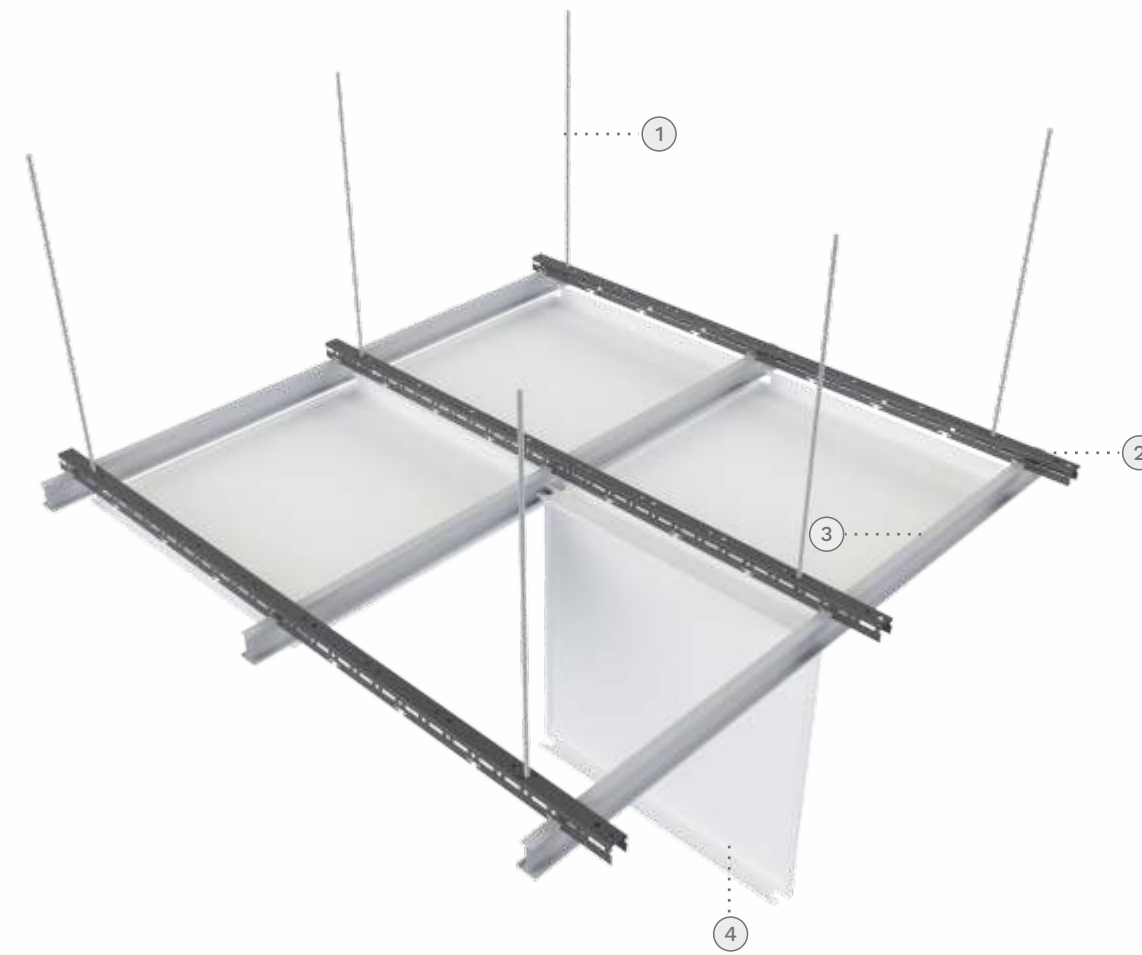

No.	Description
1	GI Thread Rod
2	Supporting Runner
3	Hook On Channel
4	Hook On Til

 Corrosion Resistance	 Fire Classification	 Easy Wash/Clean	 Light Reflectance
 Acoustic Property	 Humidity Resistance	 Anti Microbial	 Green Building Material

HOOK ON TILE

HOOK ON TILE is like a clip in tile only except for the clip, hooks are used in the member to attach it to the carriers. Hooks are attached to the edges of the member and are easy to detach when needed. It holds the member well in place and is also sturdy. The members are easy to coat and finish and give a neat look to the ceiling.

PANEL SPECIFICATION

Available Sizes	Width (mm)	Length (mm)	Tegular (mm)	Thickness (mm)
Hook On Tile	600	600	13	0.50 - 1
Hook On Tile	600	1200	25	0.50 - 1
Hook On Tile	Customize as per requirement			0.50 - 1

Profile and Accessories

Extruded Support Grid	20mm	-	40	0.50 - 0.70
Carrier	-	Upto 4000	-	0.60
Big Clip	20	-	40	0.50
GI Thread Rod	-	-	-	4
Customized Profiles (For Border Finish)	-	Upto 2440	-	0.50 - 0.70



SCHEPPER

SPECIAL CEILINGS



Open Cell Ceiling

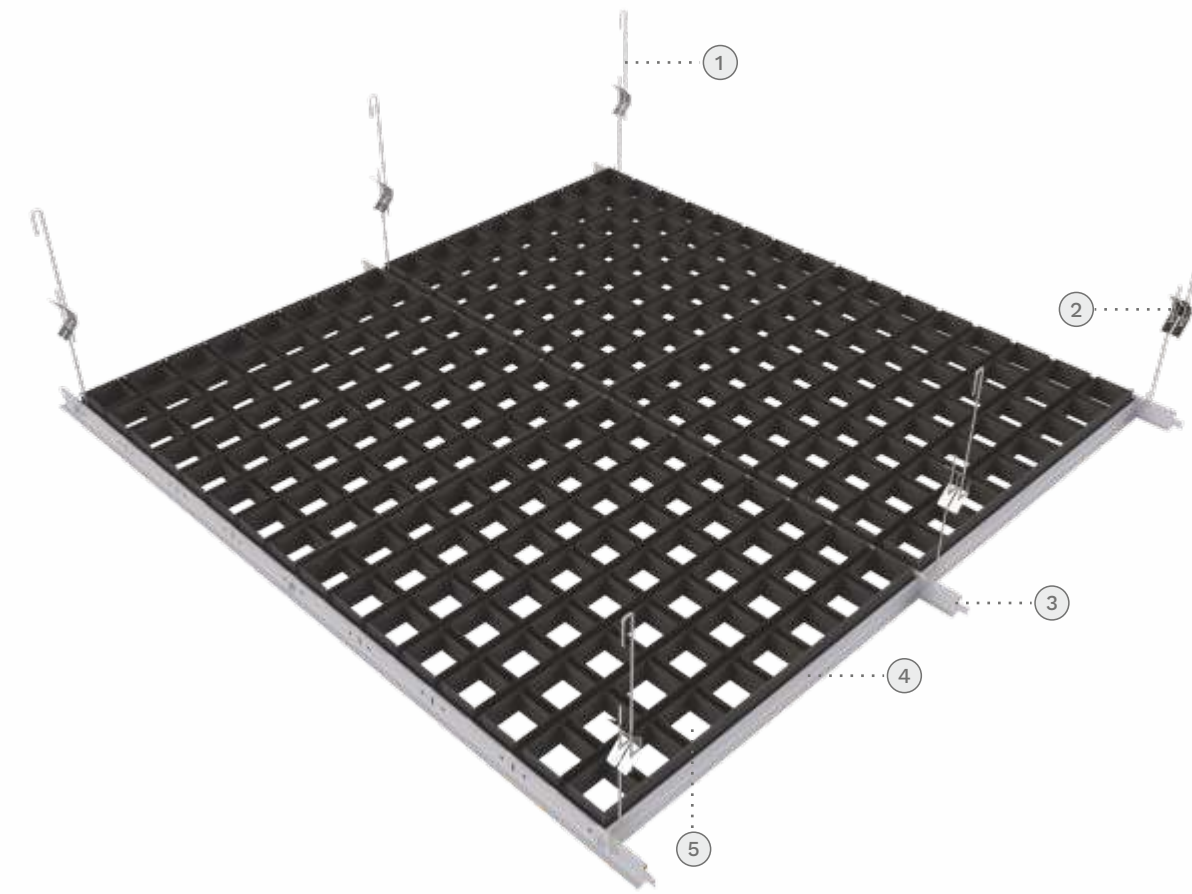
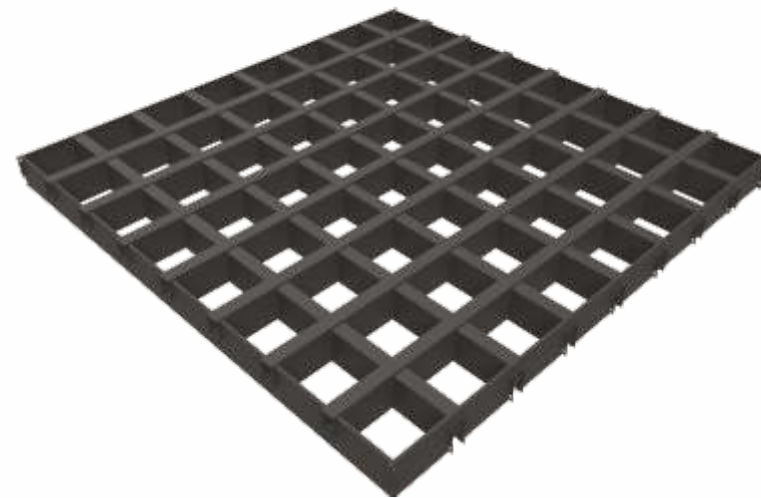

No.	Description
1	GI Rod
2	Butterfly Clip
3	Main 'TEE'
4	Cross 'TEE'
5	Open Cell



Corrosion Resistance



Fire Classification



Easy Wash/Clean



Light Reflectance



Acoustic Property



Humidity Resistance



Anti Microbial



Green Building Material

OPEN CELL CEILING

OPEN CELL CEILING is a set of multiple cell options with T-15 grids suitable where open and light constructions are desired. These are used to accommodate air diffusers and lay-in light systems, giving a stylish edge to the structure. This system gives 100% accessibility and is fast and easy to install in a standard suspension system.

PANEL SPECIFICATION





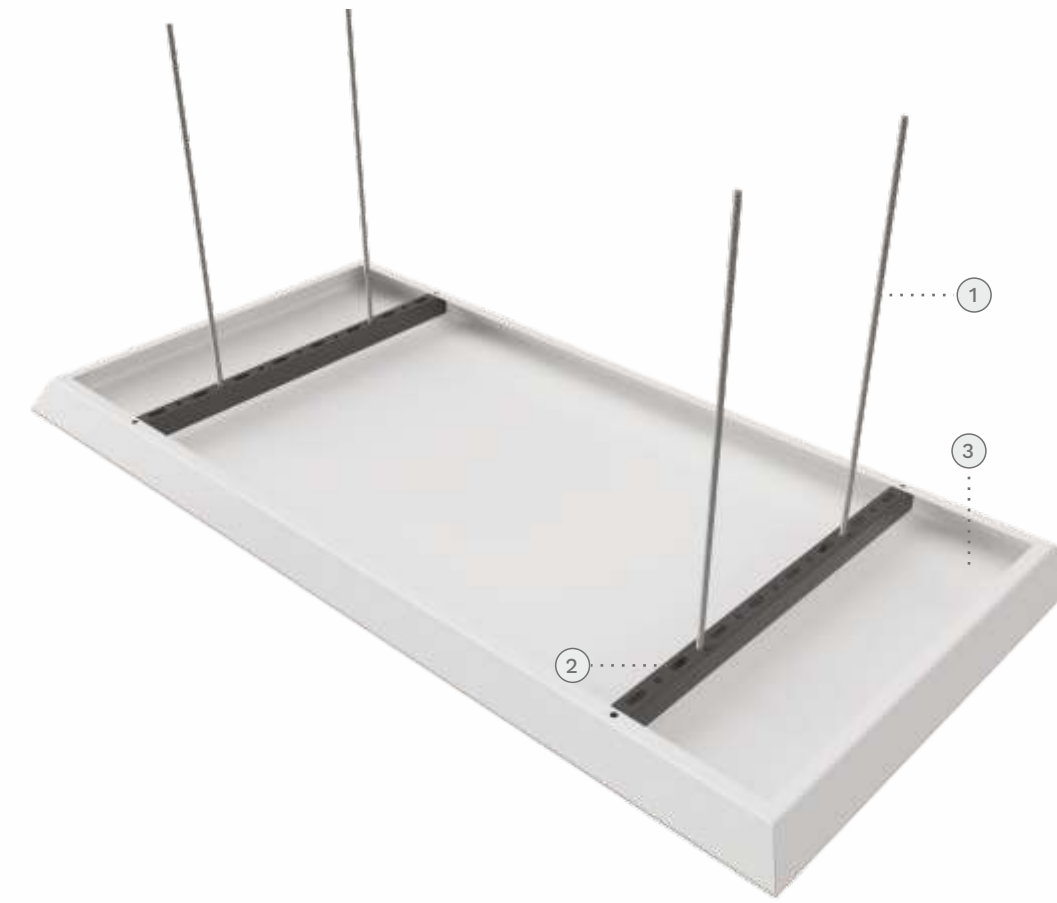

Available Sizes	Width (mm)	Frame Size	Depth (mm)	Thickness (mm)
Open Cell 75*75	15	600*600	38	0.50 - 0.71
Open Cell 100*100 Module	15	600*600	38	0.50 - 0.71
Open Cell 150*150 Module	15	600*600	38	0.50 - 0.71

Profile and Accessories

Cross 'TEE'	15	600	32 / 38	0.30
Main 'TEE'	15	3000	32 / 38	0.30
Butterfly Clip	-	-	-	0.50
GI Rod	-	-	-	4
Customized Profiles (For Border Finish)	-	Upto 2440		0.50 - 0.70



No.	Description
1	Threaded Rod
2	Carrier
3	Cloud Tile

-  Corrosion Resistance
-  Fire Classification
-  Easy Wash/Clean
-  Light Reflectance
-  Acoustic Property
-  Humidity Resistance
-  Anti Microbial
-  Green Building Material

CLOUD CEILING

CLOUD CEILING options can be especially effective for noise reduction since they absorb sound from the front and back of the panels. They are available in different shapes, materials, and sizes and can be installed according to the design requirements of the project. These are best suited when wall space is limited, or ceiling heights are too low for traditional baffles.

PANEL SPECIFICATION

Available Sizes	Width (mm)	Length (mm)	Height (mm)	Thickness (mm)
Cloud Ceiling-1	300-600	-	50	0.50 - 0.71
Cloud Ceiling-2	600-600	-	50	0.50 - 0.71
Cloud Ceiling-3	600-1200	-	50	0.50 - 0.71
Cloud Ceiling-4	Customize	-	50	0.50 - 0.71

Profile and Accessories

Carrier	-	150	-	0.50 - 0.70
Main Runner	15	-	40	0.50 - 0.70
Threaded Rod	-	-	-	6

Cloud Ceiling





Bezel Ceiling

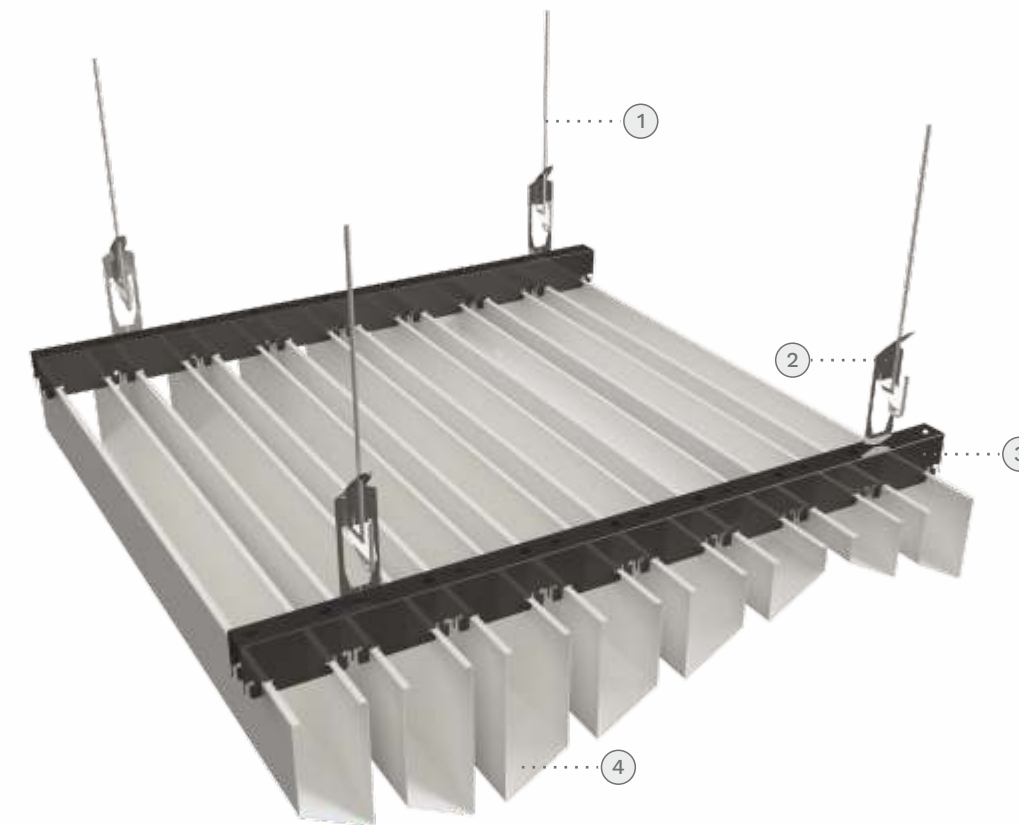

No.	Description
1	GI Rod
2	Height Adjustable Clip
3	Carrier
4	Bezel Ceiling



BEZEL CEILING

BEZEL CEILING is a similar version of U Shape Baffle Ceiling. Each panel has a different depth on both sides giving an inclination of certain degrees. This type of ceiling is most used for a zig-zag pattern visualization and the pattern can also be further modified. This is a convenient option for unique architectural designs with easy installation and maintenance and a cost-friendly mode as compared to others.

PANEL SPECIFICATION

Available Sizes	Width (mm)	Length (mm)	Depth (mm)	Thickness (mm)
BZ 35 Height	-	Upto 4000	35	0.50 - 0.71
BZ 50 Height	-	Upto 4000	60	0.50 - 0.71
BZ 65 Height	-	Upto 4000	65	0.50 - 0.71

Profile and Accessories

Panel Coupler	-	150	-	0.50 - 0.70
Carrier	20	Upto 4000	40	0.60
Carrier Coupler	20	-	40	0.60



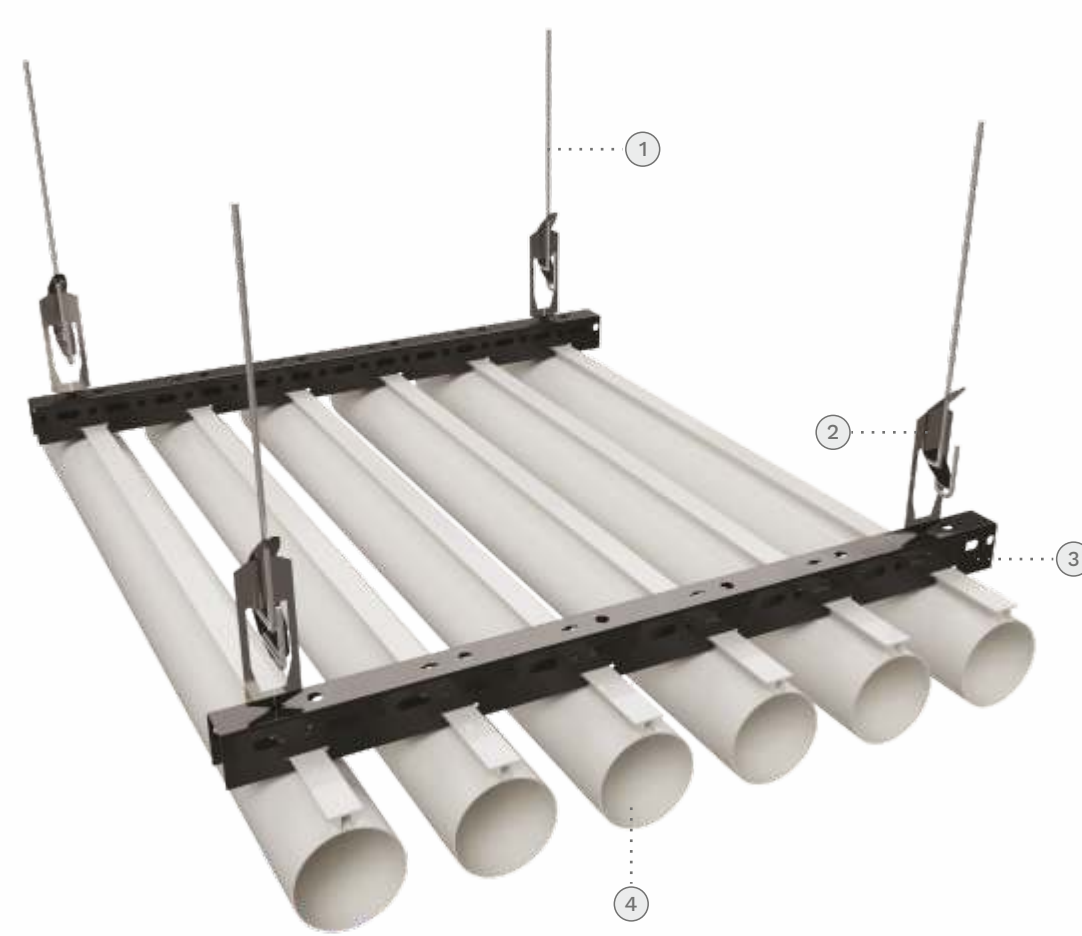

No.	Description
1	GI Rod
2	Height Adjustable Clip
3	Carrier
4	Tube Baffle Panel

-  Corrosion Resistance
-  Fire Classification
-  Easy Wash/Clean
-  Light Reflectance
-  Acoustic Property
-  Humidity Resistance
-  Anti Microbial
-  Green Building Material

TUBE BAFFLE

A TUBE BAFFLE as named is a circular tube baffle most used in huge structures such as airports, and industrial and commercial buildings. It is best suited when an alluring, eye catching design is required. It is durable and offers a variety of colours and finishes.

Tube Baffle



PANEL SPECIFICATION

Available Sizes	Width (mm)	Length (mm)	Dia (mm)	Thickness (mm)
Tube 60	60	Upto 5000	60	0.70 - 1.5
Tube 85	85	Upto 5000	85	0.70 - 1.5

Profile and Accessories

Panel Coupler	60-85	150	60-85	0.70
Carrier	20	Upto 4000	40	0.60
Carrier Coupler	20	-	40	0.50
End Cap	20	-	-	-





SCHEPPER

EXTERIOR

CLADDING / ELEVATION



Wall Cladding 84C



No.	Description
1	L Clit
2	GI Stud (Main Support)
3	Cladding Carrier
4	84C Panel

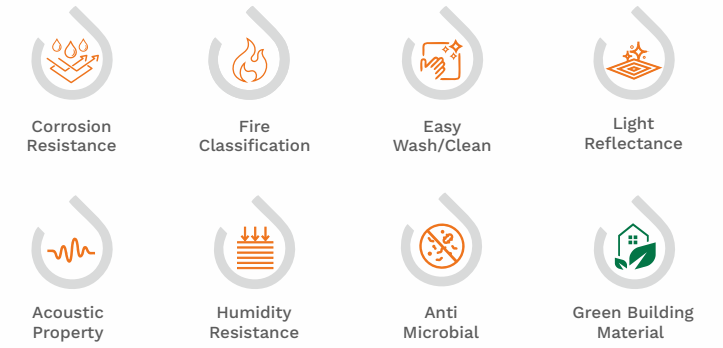

WALL CLADDING 84C

WALL CLADDING 84C is a vertical placement of metal panels attached directly to the exterior of the walls of a structure. These come in different sizes and can be coated with different colors and finishes. This cladding adds an aesthetic feature and is durable with fewer maintenance needs. According to requirements, these can be removed individually, fixed, and can be placed back without disturbing other panels.

PANEL SPECIFICATION

Available Sizes	Width (mm)	Length (mm)	Depth (mm)	Thickness (mm)
84C	84	Upto 5000	15	0.50 - 0.71
184C	184	Upto 5000	15	0.50 - 0.71

Profile and Accessories

Carrier	20	Upto 4000	40	0.60
Stud	25	Upto 4000	25	1.20
L Clit	-	-	-	1.20





U Shape Cladding

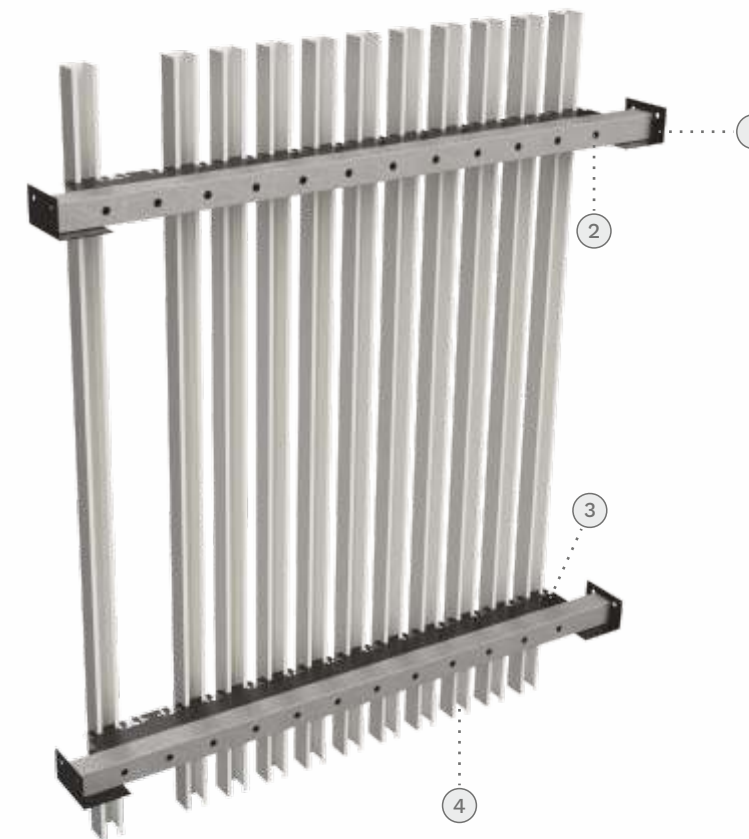
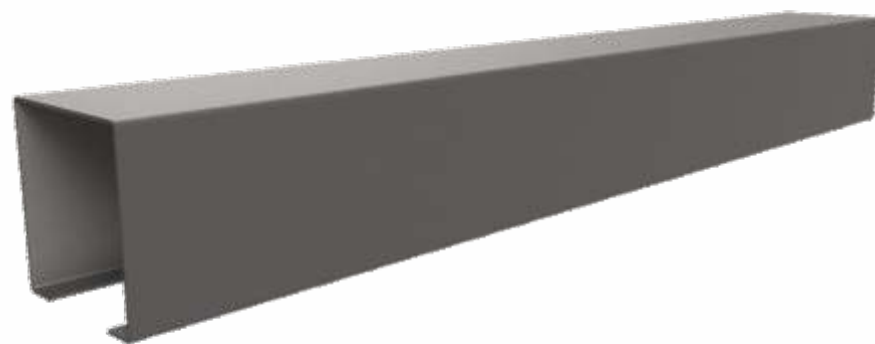

No.	Description
1	L Clit
2	GI Stud (Main Support)
3	Cladding Carrier
4	U Shape Panel

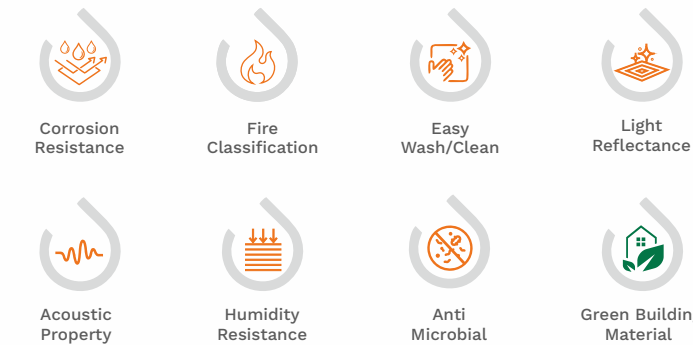

U SHAPE CLADDING

U SHAPE CLADDING is an alternate method to linear cladding. Baffles of various sizes can be arranged in different gaps between each member giving a continuous look without enclosing each panel next to the other. It can be given various colors, finishes, and coating and is more efficient. It is corrosion-resistant, weather-resistant, and easy to maintain.

PANEL SPECIFICATION

Available Sizes	Width (mm)	Length (mm)	Depth (mm)	Thickness (mm)
U Shape 13*50*13 13*75*13	50 - 75	Upto 5000	13	0.50 - 0.71
U Shape 25*25*25 25*50*25 25*75*25	25 - 50- 75	Upto 5000	25	0.50 - 0.71
U Shape 50*25*50 50*50*50 50*75*50	25 - 50- 75	Upto 5000	50	0.50 - 0.71
U Shape 75*25*75 75*50*75	25	Upto 5000	75	0.50 - 0.71

Profile and Accessories

Carrier	20	Upto 4000	40	0.60
Stud	25	-	25	1.20
L Clit	-	-	-	1.20



U Shape Cladding Multi Width



No.	Description
1	L Clit
2	G Stud (Main Support)
3	Cladding Carrier
4	U Shape Panel

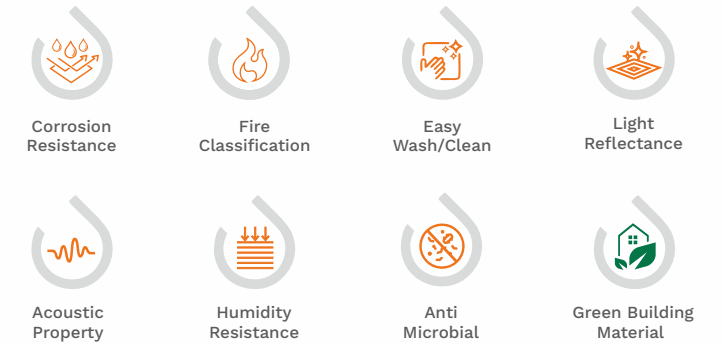

U SHAPE CLADDING MULTI WIDTH

U SHAPE CLADDING MULTI WIDTH is an alternate method to linear cladding. Baffles of various widths can be arranged in certain gaps between each member giving a continuous look without enclosing each panel next to the other. It can be given various colors, finishes, and coating and is more efficient. It is corrosion resistant, weather-resistant, and easy to maintain.

PANEL SPECIFICATION

Available Sizes	Width (mm)	Length (mm)	Depth (mm)	Thickness (mm)
U Shape 13*50*13 13*75*13	50 - 75	Upto 5000	13	0.50 - 0.71
U Shape 25*25*25 25*50*25 25*75*25	25 - 50 - 75	Upto 5000	25	0.50 - 0.71
U Shape 50*25*50 50*50*50 50*75*50	25 - 50 - 75	Upto 5000	50	0.50 - 0.71
U Shape 75*25*75	25	Upto 5000	75	0.50 - 0.71
U Shape 100*25*100	25	Upto 5000	100	0.50 - 0.71

Profile and Accessories

Carrier	20	Upto 4000	40	0.60
Stud	25	-	25	1.20
L Clit	-	-	-	1.20







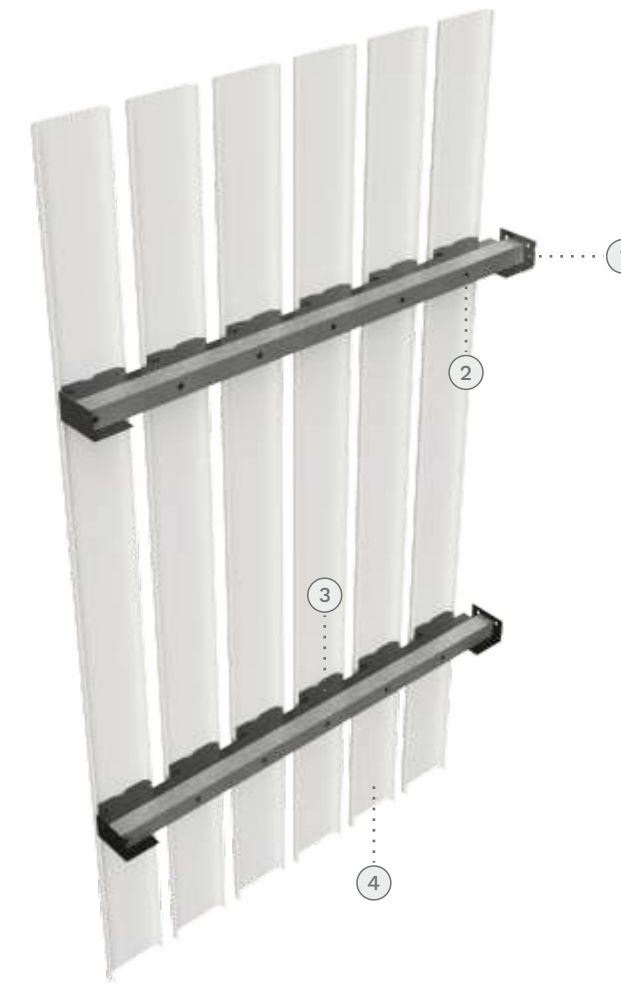





Cladding 84R



No.	Description
1	L Clit
2	GI Stud (Main Support)
3	Cladding Carrier
4	84R Panel

 Corrosion Resistance	 Fire Classification	 Easy Wash/Clean	 Light Reflectance
 Acoustic Property	 Humidity Resistance	 Anti Microbial	 Green Building Material

CLADDING 84R

38R 84R 184R cladding systems allow light and air to travel easily through the system. These panels get a unique touch with a special powder-coated finish. Tested for resistance to wind loads, these are a low-cost solution for external building renovation and for new construction.

PANEL SPECIFICATION

Available Sizes	Width (mm)	Length (mm)	Depth (mm)	Thickness (mm)
38R	38	Upto 5000	15	0.50 - 0.71
60R	60	Upto 5000	15	0.50 - 0.71
84R	84	Upto 5000	15	0.50 - 0.71
184R	184	Upto 5000	15	0.50 - 0.71

Profile and Accessories

Carrier	20	-	40	0.60
Stud	25	-	25	1.20
L Clit	-	-	-	1.20

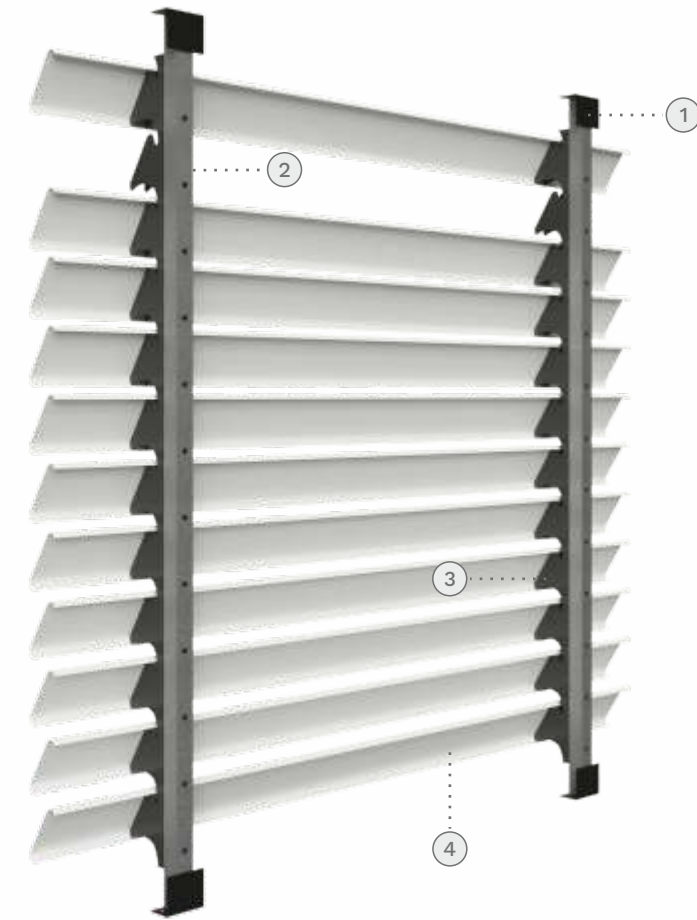

No.	Description
1	L Clit
2	GI Stud (Main Support)
3	SL4 Carrier
4	84R Panel



Corrosion Resistance



Fire Classification



Easy Wash/Clean



Light Reflectance



Acoustic Property



Humidity Resistance



Anti Microbial



Green Building Material

LOUVERS SL4

SL4 are sun louvers basically used in the exterior of the structure. It balances out the distribution of natural light without completely cutting it. It serves a bunch of range of architectural needs and is easy to use and install.

PANEL SPECIFICATION

Available Sizes	Width (mm)	Length (mm)	Depth (mm)	Thickness (mm)
84R Panel	84	Upto 5000	15	0.50 - 0.71

Profile and Accessories

Carrier	20	Upto 4000	-	0.60
Stud	25	-	25	1.20
L Clit	-	2400	-	1.20

Louvers SL4





Louvers H3



No.	Description
1	L Clit
2	GI Stud (Main Support)
3	H3 Louvers Carrier
4	84R Panel



Corrosion Resistance



Fire Classification



Easy Wash/Clean



Light Reflectance



Acoustic Property



Humidity Resistance



Anti Microbial



Green Building Material

LOUVERS H3

H3 are sun louvers basically used in the exterior of the structure. It balances out the distribution of natural light without completely cutting it. It serves a bunch of range of architectural needs and is easy to use and install.

PANEL SPECIFICATION

Available Sizes	Width (mm)	Length (mm)	Depth (mm)	Thickness (mm)
84R Panel	84	Upto 5000	15	0.50 - 0.71

Profile and Accessories

Carrier	20	Upto 4000	-	0.60
Stud	25	-	25	1.20
L Clit	20	2400	40	1.2



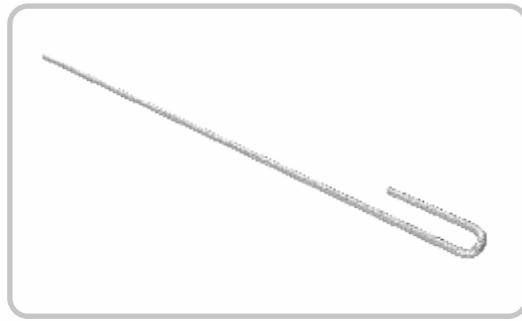

GI ROD
Grid

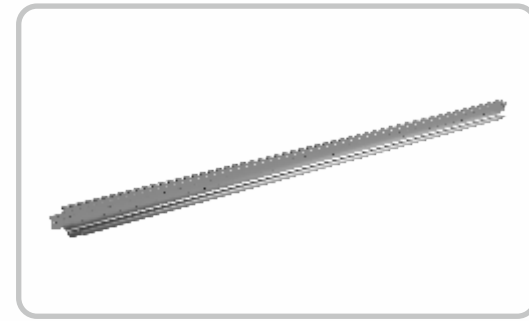

GI CROSS 'TEE'
Grid

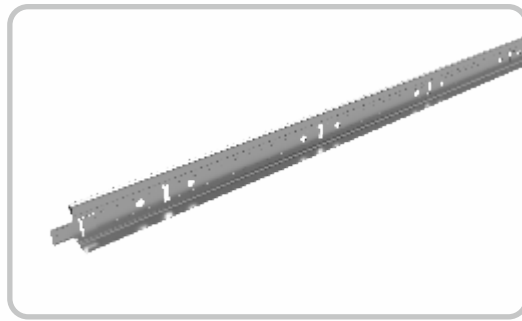

GI MAIN 'TEE'
Grid



THREDED ROD
Grid

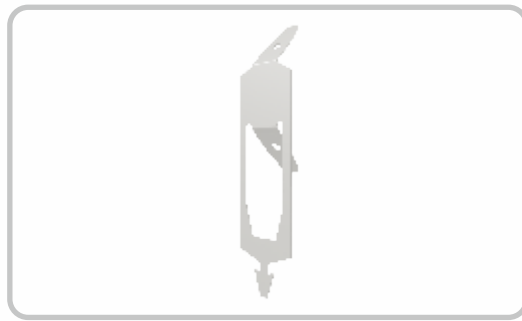

HEIGHT ADJUSTABLE CLIP
Accessories

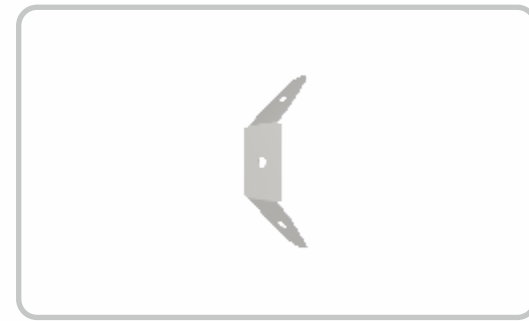

SMALL CLIP
Accessories

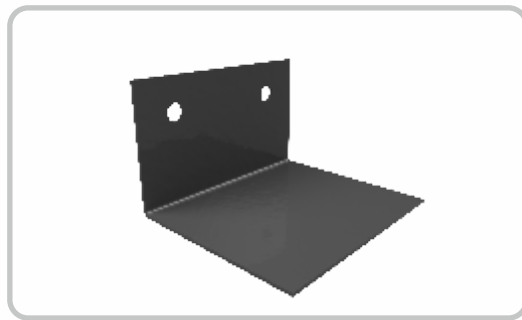

L CLIT
Accessories



SELF SCREW
Accessories



BUTTERFLY CLIP
Accessories



CEILING FASTNER
Accessories



EDGE PROFILE
Profile



'C' ANGLE
Profile



'G' ANGLE
Profile



BAFFLE END CAP
Profile

Grid / Accessories / Finish Profiles

Perforation Pattern

For better acoustic performance we can deliver various options with perforation design.

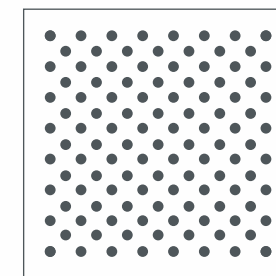

Ø1.6 mm

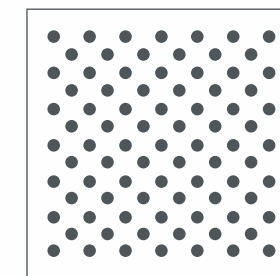

Ø1.8 mm

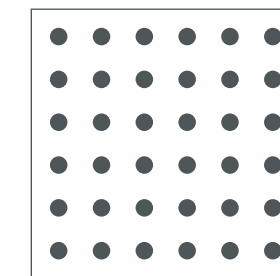



Ø2.5 mm





B-1312, Sivanta One, Opp Nalli Sarees Showroom,
Ashram Road, Pritamnagar, Ahmedabad, India, 380007
Call : 1800889 0245 | Email : info@schepper.in | sales@schepper.in

Unit 1 - Schepper Metal Ceilings Private Limited
B/h Tathastu Party Plot, Near Ognaj Toll Plaza,
Sardar Patel Ring Road, Ahmedabad, Gujarat 380060

-  schepper.india
-  schepper.india
-  schepperenterpriseindia

